

m a t e r i a l e d a r i c a m o



Pietre Swarovski con foro





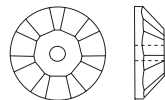











































Articolo 3128



Misura:

Confezione:

	 3 mm 1440 pz.	 4 mm 1440 pz.	 5 mm 720 pz.	 6 mm 360 pz.	 7 mm 144 pz.	 8 mm 144 pz.	 10 mm 72 pz.
 Crystal (001)	X	X	X				
 Crystal F (001)	X	X	X	X	X	X	X
 Crystal AB (001 AB)	X	X	X				
 Crystal AB F (001 AB)	X	X	X	X	X	X	X
 Crystal Copper F (001 COP)	X	X	X				
 Crystal Dorado M (001 DOR)	X	X	X				
 Crystal Golden Shadow F (001 GSHA)	X	X	X				
 Crystal Metallic Blue F (001 METBL)	X	X	X				
 Crystal Moonlight F (001 MOL)	X	X	X				
 Crystal Sage M (001 SAG)	X	X	X				
 Crystal Satin M (001 SAT)	X	X	X				
 Crystal Silver Shade F (001 SSHA)	X	X	X				
 Crystal Tabac M (001 TAB)	X	X	X				
 Crystal Transmission V (001 TRA)	X	X	X				
 Crystal Volcano M (001 VOL)	X	X	X				
 Jet (280)	X	X	X	X	X	X	X
 Jet Hematite (280 HEM)	X	X	X				
 Jet Nut (280 NUT)	X	X	X				
 Amethyst F (204)	X	X	X				
 Aquamarine F (202)	X	X	X				
 Black Diamond F (215)	X	X	X				
 Emerald F (205)	X	X	X				
 Erinite F (360)	X	X	X				
 Fuchsia F (502)	X	X	X				
 Hyacinth F (236)	X	X	X				
 Jonquil F (213)	X	X	X				
 Khaki F (550)	X	X	X				
 Light Amethyst F (212)	X	X	X				
 Light Colorado Topaz F (246)	X	X	X				
 Light Grey Opal F (383)	X	X	X				
 Light Peach F (362)	X	X	X				
 Light Rose F (223)	X	X	X				
 Light Sapphire F (211)	X	X	X				
 Light Siam F (227)	X	X	X				
 Light Topaz F (226)	X	X	X				
 Mint Alabaster F (397)	X	X	X				
 Mocca F (286)	X	X	X				
 Olivine F (228)	X	X	X				
 Padparadscha F (542)	X	X	X				





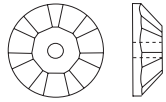













Articolo 3128



Misura:

Confezione:

	 3 mm	 4 mm	 5 mm	 6 mm	 7 mm	 8 mm	 10 mm
	1440 pz.	1440 pz.	720 pz.	360 pz.	144 pz.	144 pz.	72 pz.
 Palace Green Opal F (393)	X	X	X				
 Peridot F (214)	X	X	X				
 Rose F (209)	X	X	X				
 Sapphire F (206)	X	X	X				
 Siam F (208)	X	X	X				
 Smoked Topaz F (220)	X	X	X				
 Sun F (248)	X	X	X				
 Tanzanite F (539)	X	X	X				
 Topaz F (203)	X	X	X				





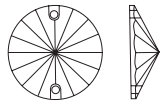









Articolo 3200



Misura:









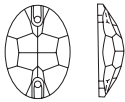
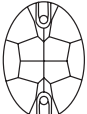
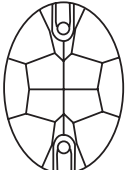

Confezione:

	 10 mm	 12 mm	 14 mm	 16 mm	 18 mm
	72 pz.	48 pz.	72 pz.	72 pz.	72 pz.
 Crystal F (001)	X	X	X	X	X
 Crystal AB F (001 AB)	X	X	X	X	X
 Crystal Dorado M (001 DOR)	X	X	X		
 Crystal Satin M (001 SAT)	X	X	X		
 Crystal Tabac M (001 TAB)	X	X	X		
 Crystal Volcano M (001 VOL)	X	X	X		
 Jet (280)	X	X	X		
 Jet Hematite (280 HEM)	X	X	X		
 Jet Nut (280 NUT)	X	X	X		
 Black Diamond F (215)	X	X	X		
 Erinite F (360)	X	X	X		
 Light Colorado Topaz F (246)	X	X	X		
 Light Rose F (223)	X	X	X		
 Light Sapphire F (211)	X	X	X		
 Light Siam F (227)	X	X	X		
 Light Topaz F (226)	X	X	X		
 Padparadscha F (542)	X	X	X		
 Sun F (248)	X	X	X		
 Tanzanite F (539)	X	X	X		

Pietre Swarovski con foro







Articolo 3210

			
Misura:	10x7 mm	16x11 mm	24x17 mm
Confezione:	72 pz.	72 pz.	24 pz.
 Crystal F (001)	X	X	X
 Crystal AB F (001 AB)	X	X	X
 Crystal Copper F (001 COP)	X	X	X
 Crystal Satin M (001 SAT)	X	X	X
 Crystal Transmission V (001 TRAV)	X		
 Jet (280)	X		
 Light Amethyst F (212)	X		
 Light Colorado Topaz F (246)	X		
 Light Sapphire F (211)	X		
 Olivine (228)	X		

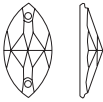







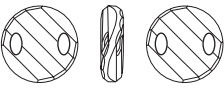
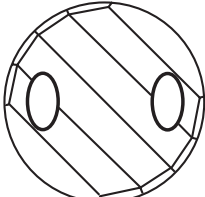

Articolo 3223

		
Misura:	12x6 mm	18x9 mm
Confezione:	48 pz.	36 pz.
 Crystal F (001)	X	X
 Crystal AB F (001 AB)	X	X
 Jet (280)	X	X



Articolo 3221

		
Misura:	18 mm	28 mm
Confezione:	72 pz.	24 pz.
 Crystal (001)	X	X
 Crystal F (001)	X	X
 Crystal Copper (001 COP)	X	X
 Crystal Golden Shadow (001 GSHA)	X	X
 Crystal Moonlight (001 MOL)	X	X
 Crystal Silver Shade (001 SSHA)	X	X
 Jet (280)	X	X



Articolo 3230

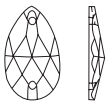

Misura:

Confezione:

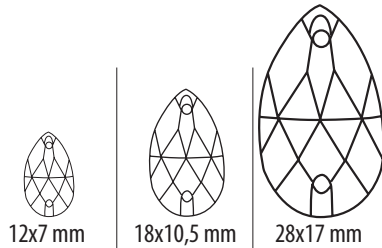

12x7 mm

96 pz.

18x10,5 mm

72 pz.

28x17 mm

24 pz.

Crystal F (001)	X	X	X
Crystal AB F (001 AB)	X	X	X
Crystal Copper F (001 COP)	X	X	X
Crystal Satin M (001 SAT)	X	X	X
Crystal Transmission V (001 TRAV)	X	X	
Jet (280)	X		
Light Amethyst F (212)	X		
Light Colorado Topaz F (246)	X		
Light Sapphire F (211)	X		
Olivine F (228)	X		



Articolo 3250

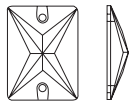

Misura:

Confezione:

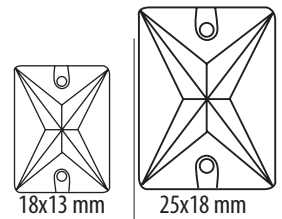

18x13 mm

72 pz.

25x18 mm

24 pz.

Crystal F (001)	X	X
Crystal AB F (001 AB)	X	X
Crystal Satin M (001 SAT)	X	
Crystal Tabac M (001 TAB)	X	
Jet (280)	X	X
Jet Hematite (280 HEM)	X	
Jet Nut (280 NUT)	X	



Articolo 3240

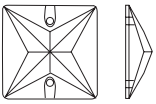

Misura:

Confezione:

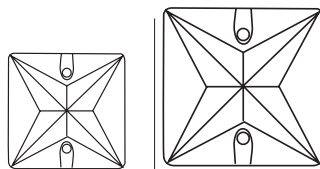

16 mm

72 pz.

22 mm

24 pz.

Crystal F (001)	X	X
Crystal AB F (001 AB)	X	X
Crystal Dorado M (001 DOR)	X	X
Crystal Sage M (001 SAG)	X	
Crystal Satin M (001 SAT)	X	X
Crystal Volcano M (001 VOL)	X	
Jet (280)	X	X
Jet Hematite (280 HEM)	X	X
Jet Nut (280 NUT)	X	X



Articolo 3255

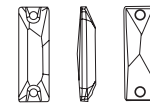

Misura:

Confezione:

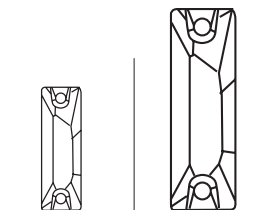

18x6 mm

96 pz.

26x8,5 mm

48 pz.

Crystal F (001)	X	X
Crystal Copper F (001 COP)	X	X
Crystal Golden Shadow F (001 GSHA)	X	X
Crystal Moonlight F (001 MOL)	X	X
Crystal Silver Shade F (001 SSHA)	X	X
Crystal Volcano F (001 VOL)	X	X
Jet (280)	X	X

Pietre Swarovski con foro



Articolo 3256

Misura:	14x8,5 mm	19x11,5 mm
Confezione:	192 pz.	96 pz.
Crystal F (001)	X	X
Crystal Copper F (001 COP)	X	X
Crystal Golden Shadow F (001 GSHA)	X	X
Crystal Moonlight F (001 MOL)	X	X
Crystal Silver Shade F (001 SSHA)	X	X
Jet (280)	X	X



Articolo 3270

Misura:	16 mm	22 mm
Confezione:	72 pz.	24 pz.
Crystal F (001)	X	X
Crystal AB F (001 AB)	X	X
Crystal Dorado M (001 DOR)	X	X
Crystal Satin M (001 SAT)	X	X
Crystal Tabac M (001 TAB)	X	X
Crystal Volcano M (001 VOL)	X	X
Jet (280)	X	X
Jet Hematite (280 HEM)	X	X
Jet Nut (280 NUT)	X	X



Articolo 3265

Misura:	20x16 mm	26x21 mm
Confezione:	72 pz.	20 pz.
Crystal F (001)	X	X
Crystal AB F (001 AB)	X	X
Crystal Copper F (001 COP)	X	X
Crystal Golden Shadow F (001 GSHA)	X	X
Crystal Silver Shade F (001 SSHA)	X	X
Crystal Volcano M (001 VOL)	X	X
Jet (280)	X	X



Articolo 3400

Misura	6 mm	8 mm	10 mm
Confezione:	360 pz.	288 pz.	288 pz.
Crystal F (001)	X	X	X
Crystal AB F (001 AB)	X	X	X
Crystal Sage M (001 SAG)	X		
Crystal Satin M (001 SAT)	X		
Crystal Tabac M (001 TAB)	X		
Crystal Volcano M (001 VOL)	X		
Jet (280)	X	X	X
Jet Hematite (280 HEM)	X		
Jet Nut (280 NUT)	X		
Jonquil F (213)	X		
Light Colorado Topaz F (246)	X		
Light Rose F (223)	X		
Light Sapphire F (211)	X		
Siam F (208)	X		



Articolo 3700

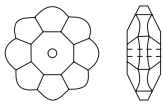

Misura:

Confezione:

	 6 mm 720 pz.	 8 mm 288 pz.	 10 mm 288 pz.	 12 mm 144 pz.	 14 mm 144 pz.
 Crystal (001)	X	X	X	X	
 Crystal F (001)	X	X	X	X	X
 Crystal AB (001 AB)	X	X	X	X	X
 Crystal AB F (001 AB)	X	X	X	X	
 Crystal Heliotrope (001 HEL)	X	X	X		
 Crystal Satin M (001 SAT)	X	X	X		
 Crystal Tabac M (001 TAB)	X	X	X		
 Crystal Transmission V (001 TRAV)	X	X	X		
 Crystal Vitrail Medium (001 VM)	X	X	X		
 Crystal Volcano M (001 VOL)	X	X	X		
 Jet (280)	X	X	X	X	X
 Amethyst (204)	X	X	X		
 Emerald (205)	X	X	X		
 Erinite (360)	X	X	X		
 Fuchsia (502)	X	X	X		
 Jonquil (213)	X	X	X		
 Light Amethyst (212)	X	X	X		
 Light Colorado Topaz (246)	X	X	X		
 Light Peach (362)	X	X	X		
 Light Rose (223)	X	X	X		
 Light Sapphire (211)	X	X	X		
 Light Siam (227)	X	X	X	X	
 Peridot (214)	X	X	X	X	
 Rose (209)	X	X	X		
 Sapphire (206)	X	X	X		
 Siam (208)	X	X	X		
 Sun (248)	X	X	X		
 Tanzanite (539)	X	X	X		
 Topaz (203)	X	X	X	X	

Articolo 5301



Misura:	2,5	3	4	5	6 mm	8 mm	10 mm	
Confezione:	1440	1440	1440	720	360 pz.	288 pz.	144 pz.	

Crystal (001)	X	X	X	X	X	X	X	
Crystal AB (001 AB)	X	X	X	X	X	X	X	
Crystal AB 2x (001 AB2)		X	X		X			
Crystal AB Satin (001 ABSAT)		X	X	X	X			
Crystal CAL (001 CAL)		X	X	X	X			
Crystal Copper (001 COP)	X	X	X	X	X			
Crystal Dorado 2x (001 DOR2)		X	X	X	X			
Crystal Golden Shadow (001 GSHA)	X	X	X	X	X			
Crystal Heliotrope (001 HEL)		X	X					
Crystal Moonlight (001 MOL)		X	X	X	X			
Crystal Metallic Blue 2x (001 METBL2)		X	X	X	X			
Crystal Satin (001 SAT)		X	X	X	X			
Crystal Silver Shade (001 SSHA)	X	X	X	X	X			
Crystal Vitrail Medium (001 VM)		X	X					
Jet (280)	X	X	X	X	X	X	X	
Jet AB (280 AB)		X	X	X	X	X		
Jet AB 2x (280 AB2)		X	X	X	X			
Jet Hematite (280 HEM)		X	X	X	X	X		
Jet Hematite 2x (280 HEM2)		X	X	X	X	X		
Jet Nut 2x (280 NUT)		X	X	X	X			
Amethyst (204)	X	X	X	X	X	X	X	
Amethyst AB (204 AB)		X	X	X	X			
Amethyst AB 2x (204 AB)			X					
Amethyst Satin (204 SAT)			X					
Aquamarine (202)	X	X	X	X	X	X	X	
Aquamarine AB (202 AB)		X	X	X	X	X		
Aquamarine AB 2x (202 AB2)			X					
Aquamarine Satin (202 SAT)			X					
Black Diamond (215)	X	X	X	X	X	X		
Black Diamond AB (215 AB)		X	X	X	X			
Black Diamond AB 2x (215 AB2)			X					
Black Diamond Satin (215 SAT)			X					
Blue Zircon (229)		X	X	X	X	X		
Blue Zircon AB (229 AB)			X					
Blue Zircon AB 2x (229 AB2)			X					
Burgundy (515)		X	X	X	X			
Burgundy AB (515 SAT)			X					
Burgundy Satin (515 SAT)			X					
Capri Blue (243)		X	X	X	X	X		
Capri Blue AB (243 AB)		X	X					

Articolo 5301



Misura:	2,5	3	4	5	6 mm	8 mm	10 mm	
Confezione:	1440	1440	1440	720	360 pz.	288 pz.	144 pz.	

Capri Blue AB 2x (243 AB)			X					
Capri Blue Satin (243 SAT)			X					
Caribbean Blue Opal (394)		X	X	X	X	X		
Caribbean Blue Opal AB (394 AB)			X					
Citrine (249)		X	X	X	X	X		
Citrine AB (249 AB)			X					
Chrysolite (238)		X	X	X	X	X		
Chrysolite AB (238 AB)			X	X	X			
Chrysolite Satin (238 SAT)			X					
Dark Red Coral (396)		X	X	X	X	X		
Dark Red Coral AB (396 AB)			X					
Emerald (205)	X	X	X	X	X	X	X	
Emerald AB (205 AB)		X	X	X	X			
Emerald AB 2x (205 AB2)			X					
Emerald Satin (205 AB)			X					
Erinite (360)		X	X	X	X	X		
Erinite AB (360 AB)			X					
Erinite Satin (360 SAT)			X					
Fireopal (237)		X	X	X	X	X		
Fireopal AB (237 AB)			X					
Fuchsia (502)	X	X	X	X	X	X	X	
Fuchsia AB (502 AB)		X	X	X	X			
Fuchsia AB 2x (502 AB2)			X					
Fuchsia Satin (502 SAT)			X					
Garnet (241)		X	X	X	X	X		
Garnet AB (241 AB)			X					
Garnet AB 2x (241 AB2)			X					
Garnet Satin (241 SAT)			X					
Hyacinth (236)		X	X	X	X	X		
Hyacinth AB (236 AB)		X	X					
Hyacinth AB 2x (236 AB2)			X					
Hyacinth Satin (236 SAT)			X					
Indian Red (374)		X	X	X	X	X		
Indian Red AB (374 AB)			X					
Indian Red Satin (374 SAT)			X					
Indian Sapphire (217)		X	X	X	X			
Indian Sapphire AB (217 AB)			X					
Indian Sapphire Satin (217 SAT)			X					
Indicolite (379)		X	X	X	X	X		
Indicolite AB (379 AB)			X		X			
Indicolite Satin (379 SAT)			X					

Articolo 5301



Misura:	2,5	3	4	5	6 mm	8 mm	10 mm	
Confezione:	1440	1440	1440	720	360 pz.	288 pz.	144 pz.	

Jonquil (213)	X	X	X	X	X	X	
Jonquil AB (213 AB)		X	X	X	X		
Jonquil AB 2x (213 AB2)			X				
Jonquil Satin (213 SAT)			X				
Khaki (550)		X	X	X	X		
Light Amethyst (212)	X	X	X	X	X	X	
Light Amethyst AB (212 AB)		X	X	X	X		
Light Amethyst AB 2x (212 AB2)			X				
Light Amethyst Satin (212 SAT)			X				
Light Azore (361)		X	X	X	X	X	
Light Azore AB (361 AB)			X		X		
Light Azore AB 2x (361 AB2)			X				
Light Azore Satin (361 SAT)			X				
Light Colorado Topaz (246)	X	X	X	X	X	X	
Light Colorado Topaz AB (246 AB)		X	X	X	X	X	
Light Colorado Topaz AB 2x (246 AB2)			X				
Light Colorado Topaz Satin (246 SAT)			X				
Light Grey Opal (383)		X	X	X	X	X	
Light Peach (362)		X	X	X	X	X	
Light Peach AB (362 AB)		X	X		X		
Light Peach AB 2x (362 AB2)			X				
Light Peach Satin (362 SAT)			X				
Light Rose (223)	X	X	X	X	X	X	X
Light Rose AB (223 AB)		X	X	X	X	X	
Light Rose AB 2x (223 AB2)			X				
Light Rose Satin (223 SAT)			X				
Light Sapphire (211)		X	X	X	X	X	
Light Sapphire AB (211 AB)		X	X	X	X		
Light Sapphire AB 2x (211 AB2)			X				
Light Sapphire Satin (211 SAT)			X				
Light Siam (227)	X	X	X	X	X	X	
Light Siam AB (227 AB)		X	X	X	X		
Light Siam AB 2x (227 AB2)			X				
Light Siam Satin (227 SAT)			X				
Light Smoked Topaz (221)	X	X	X	X	X		
Light Smoked Topaz AB (221 AB)			X				
Light Smoked Topaz Satin (221 SAT)			X				
Light Topaz (226)	X	X	X	X	X	X	
Light Topaz AB (226 AB)			X				
Light Topaz Satin (226 SAT)			X				
Lime (385)		X	X	X	X	X	

Articolo 5301



Misura:	2,5	3	4	5	6 mm	8 mm	10 mm	
Confezione:	1440	1440	1440	720	360 pz.	288 pz.	144 pz.	

Lime AB (385 AB)			X				
Lime Satin (385 SAT)			X				
Mint Alabaster (397)		X	X	X	X	X	
Mint Alabaster AB (397 AB)			X				
Mocca (286)		X	X	X	X	X	
Montana (207)		X	X	X	X	X	
Montana AB (207 AB)		X	X	X	X		
Montana AB 2x (207 AB2)			X				
Montana Satin (207 SAT)			X				
Olivine (228)	X	X	X	X	X	X	
Olivine AB (228 AB)		X	X	X	X		
Olivine AB 2x (228 AB2)			X				
Olivine Satin (228 SAT)			X				
Pacific Opal (390)		X	X	X	X	X	
Padparadscha (542)		X	X	X	X	X	
Padparadscha AB (542 AB)			X		X		
Padparadscha AB 2x (542 AB2)			X				
Padparadscha Satin (542 SAT)			X				
Palace Green Opal (393)		X	X	X	X	X	
Peridot (214)	X	X	X	X	X	X	X
Peridot AB (214 AB)			X	X	X		
Peridot AB 2x (214 AB2)			X				
Peridot Satin (214 SAT)			X				
Purple Velvet (277)		X	X	X	X	X	
Purple Velvet AB (277 AB)			X				
Rosaline (508)		X	X	X	X	X	
Rosaline AB (508 AB)			X				
Rose (209)	X	X	X	X	X	X	X
Rose AB (209 AB)		X	X	X	X	X	
Rose AB 2x (209 AB2)			X				
Rose Satin (209 SAT)			X				
Rose Alabaster (293)		X	X	X	X		
Rose Alabaster AB (293 AB)			X				
Rose Alabaster Satin (293 SAT)			X				
Rose Water Opal (395)		X	X	X	X	X	
Rose Water Opal AB (395 AB)			X				
Ruby (501)		X	X	X	X	X	
Ruby AB (501 AB)			X		X		
Ruby Satin (501 SAT)			X				
Sand Opal (287)		X	X	X	X		
Sapphire (206)	X	X	X	X	X	X	X

Articolo 5301



Misura:							
Confezione:	1440	1440	1440	720	360 pz.	288 pz.	144 pz.

Sapphire AB (206 AB)		X	X	X	X		
Sapphire AB 2x (206 AB2)			X				
Sapphire Satin (206 SAT)			X				
Siam (208)	X	X	X	X	X	X	X
Siam AB (208 AB)		X	X	X	X		
Siam AB 2x (208 AB2)			X				
Siam Satin (208 SAT)			X				
Silk (391)	X	X	X	X	X		
Silk AB (391 AB)			X				
Smoked Topaz (220)	X	X	X	X	X	X	
Smoked Topaz AB (220 AB)			X		X		
Smoked Topaz AB2 (220 AB2)			X				
Smoked Topaz Satin (220 SAT)			X				
Smoky Quartz (225)			X				
Smoky Quartz AB (225 AB)			X				
Smoky Quartz Satin (225 SAT)			X				
Sun (248)		X	X	X	X	X	
Sun AB (248 AB)			X				
Tanzanite (539)	X	X	X	X	X	X	
Tanzanite AB (539 AB)		X	X	X	X		
Tanzanite AB 2x (539 AB2)			X				
Tanzanite Satin (539 SAT)			X				
Topaz (203)	X	X	X	X	X	X	X
Topaz AB (203 AB)			X				
Topaz AB 2x (203 AB2)			X				
Topaz Satin (203 SAT)			X				
Turquoise (267)		X	X	X	X		
Turquoise AB (267 AB)		X	X		X		
Turquoise AB 2x (267 AB2)			X				
Turquoise Satin (267 SAT)			X				
Vintage Rose (319)		X	X	X	X		
Vintage Rose AB (319 AB)			X				
Violet (371)		X	X	X	X	X	
Violet AB (371 AB)		X	X		X		
Violet AB 2x (371 AB2)			X				
Violet Satin (371 SAT)			X				
Violet Opal (389)		X	X	X	X		
White Alabaster (281)	X	X	X	X	X		
White Alabaster AB (281 AB)			X				
White Alabaster Satin (281 SAT)			X				

Articolo 5301



Misura:							
Confezione:	1440	1440	1440	720	360 pz.	288 pz.	144 pz.

White Opal (234)		X	X	X	X	X	
White Opal AB (234 AB)		X	X		X		
White Opal AB 2x (234 AB2)			X				
White Opal Satin (234 SAT)			X				

Articolo 5020



Misura:				
Confezione:	1440 pz.	360 pz.	288 pz.	144 pz.

White Opal (234)	X	X	X	X
Crystal AB (001 AB)	X	X	X	X
Crystal Copper (001 COP)		X	X	X
Crystal Golden Shadow (001 GSHA)		X	X	X
Crystal Silver Shade (001 SSHA)		X	X	X
Jet (280)		X	X	X
Aquamarine (202)		X	X	X
Dark Red Coral (396)		X	X	
Black Diamond (215)		X	X	X
Light Rose (223)		X	X	X
Mint Alabaster (397)		X	X	
Peridot (214)		X	X	X
Purple Velvet (277)		X	X	X
Rose Water Opal (395)		X	X	
Siam (208)		X	X	X
Silk (391)		X	X	X
Topaz (203)		X	X	X



Articolo 5305



Misura: 5 mm 6 mm
Confezione: 720 pz. 360 pz.

Crystal (001)	X	X
Crystal AB (001 AB)	X	X
Jet (280)	X	X
Light Colorado Topaz (246)	X	X
Peridot (214)	X	X
Rose (209)	X	X
Sapphire (206)	X	X
Siam (208)	X	X
Topaz (203)	X	X



Articolo 5500

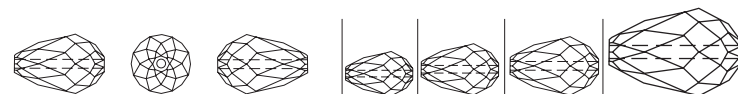

Misura: 9x6 mm 10,5x7 mm 12x8 mm 18x12 mm
Confezione: 144 pz. 288 pz. 144 pz. 72 pz.

Crystal (001)	X	X	X	X
Crystal AB (001 AB)	X	X	X	X
Jet (280)	X			
Amethyst (204)	X			
Aquamarine (202)	X			
Black Diamond (215)	X			
Indicolite (379)	X			
Light Azore (361)	X			
Light Colorado Topaz (246)	X			
Padparadscha (542)	X			
Peridot (214)	X			
Rose (209)	X			
Siam (208)	X			
Tanzanite (539)	X			
Topaz (203)	X			
White Opal (234)	X			



Articolo 5309/1

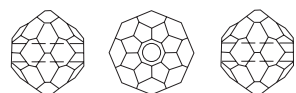

Misura: 4 mm 6 mm 8 mm
Confezione: 1440 pz. 360 pz. 288 pz.

Crystal (001)	X	X	X
Crystal AB (001 AB)	X	X	X
Crystal Cosmojet (001 COS)			X



Articolo 5205



Misura: 15x6 mm
Confezione: 288 pz.

Crystal (001)	X
Crystal AB (001 AB)	X
Crystal Copper (001 COP)	X
Crystal Golden Shadow (001 GSHA)	X
Crystal Silver Shade (001 SSHA)	X
Jet (280)	X
Amethyst (204)	X
Aquamarine (202)	X
Light Amethyst (212)	X
Light Siam (227)	X
Peridot (214)	X
Sapphire (206)	X
Topaz (203)	X



Articolo 5000

Misura:	2	3	4	5	6 mm	7 mm	8 mm	10 mm	12 mm	14 mm	16 mm	18 mm	20 mm
Confezione	1440	1440	1440	720	360 pz.	288 pz.	288 pz.	144 pz.	72 pz.	72 pz.	48 pz.	24 pz.	12 pz.
Crystal (001)	X	X	X	X	X	X	X	X	X	X	X	X	X
Crystal AB (001 AB)	X	X	X	X	X	X	X	X	X	X			
Crystal Copper (001 COP)	X	X	X		X		X	X					
Crystal Dorado (001 DOR)			X		X		X						
Crystal Dorado 2x (001 DOR2)			X		X		X						
Crystal Golden Shadow (001 GSHA)	X	X	X		X		X	X					
Crystal Metallic Blue (001 METBL)		X	X		X		X						
Crystal Moonlight (001 MOL)	X	X	X		X		X	X					
Crystal Satin (001 SAT)			X		X		X						
Crystal Silver Shade (001 SSHA)	X	X	X		X		X	X					
Crystal Vitrail Medium (001 VM)		X	X	X	X		X						
Jet (280)	X	X	X	X	X	X	X	X	X	X			
Jet AB (280 AB)		X	X	X	X	X	X						
Jet Hematite (280 HEM)		X	X	X	X		X						
Jet Hematite 2x (280 HEM2)		X	X	X	X		X						
Jet Nut 2x (280 NUT)			X		X		X						
Jet Nut 2x (280 NUT)			X		X		X						
Amethyst (204)	X	X	X	X	X	X	X	X					
Amethyst AB (204 AB)			X		X		X						
Aquamarine (202)	X	X	X	X	X	X	X	X	X	X			
Aquamarine AB (202 AB)			X		X		X	X					
Black Diamond (215)	X	X	X	X	X	X	X	X					
Black Diamond AB (215 AB)			X		X		X						
BlueZircon (229)			X		X		X						
Blue Zircon AB (229 AB)					X		X						
Burgundy (515)			X		X		X						
Burgundy AB (515 SAT)			X		X		X						
Capri Blue (243)	X	X	X	X	X	X	X	X					
Capri Blue AB (243 AB)			X		X		X						
Caribbean Blue Opal (394)		X	X		X		X						
Chrysolite (238)		X	X		X		X						
Chrysolite AB (238 AB)			X		X		X						
Dark Red Coral (396)		X	X		X		X						
Emerald (205)	X	X	X	X	X	X	X	X					
Emerald AB (205 AB)			X		X		X						
Erinite (360)		X	X		X		X						
Erinite AB (360 AB)			X		X		X						
Fireopal (237)			X		X		X						
Fireopal AB (237 AB)					X		X						



Articolo 5000

Misura:													
Confezione	2	3	4	5	6 mm	7 mm	8 mm	10 mm	12 mm	14 mm	16 mm	18 mm	20 mm
	1440	1440	1440	720	360 pz.	288 pz.	288 pz.	144 pz.	72 pz.	72 pz.	48 pz.	24 pz.	12 pz.
Fuchsia (502)	X	X	X	X	X	X	X	X					
Fuchsia AB (502 AB)			X		X		X						
Garnet (241)		X	X	X	X	X	X	X					
Garnet AB (241 AB)		X	X		X		X	X					
Hyacinth (236)	X		X		X		X						
Hyacinth AB (236 AB)			X		X		X						
Indian Red (374)			X		X		X						
Indian Red AB (374 AB)			X		X		X						
Indian Sapphire (217)			X		X		X						
Indian Sapphire AB (217 AB)			X		X		X						
Indicolite (379)		X	X		X		X						
Indicolite AB (379 AB)			X		X		X						
Jonquil (213)	X	X	X	X	X	X	X	X					
Jonquil AB (213 AB)		X	X		X		X	X					
Khaki (550)			X		X		X						
Light Amethyst (212)	X	X	X	X	X		X	X					
Light Amethyst AB (212 AB)			X		X		X	X					
Light Azure (361)	X	X	X		X		X						
Light Azure AB (361 AB)			X		X		X						
Light Colorado Topaz (246)	X	X	X	X	X	X	X	X	X	X			
Light Colorado Topaz AB (246 AB)			X		X		X	X					
Light Grey Opal (383)		X	X		X		X						
Light Peach (362)		X	X		X		X						
Light Peach AB (362 AB)			X		X		X						
Light Rose (223)	X	X	X	X	X	X	X	X	X	X			
Light Rose AB (223 AB)			X		X		X	X					
Light Sapphire (211)	X	X	X	X	X	X	X	X					
Light Sapphire AB (211 AB)			X		X		X	X					
Light Siam (227)	X	X	X	X	X	X	X	X					
Light Siam AB (227 AB)			X		X		X	X					
Light Smoked Topaz (221)			X		X		X						
Light Smoked Topaz AB (221 AB)			X		X		X						
Light Topaz (226)		X	X		X		X	X	X	X			
Light Topaz AB (226 AB)					X		X						
Lime (385)		X	X		X		X						
Lime AB (385 AB)			X		X		X						
Mint Alabaster (397)		X	X		X		X						
Mocca (286)		X	X		X		X						
Montana (207)	X	X	X	X	X		X	X					
Montana AB (207 AB)			X		X		X						



Articolo 5000

Misura:	2	3	4	5	6 mm	7 mm	8 mm	10 mm	12 mm	14 mm	16 mm	18 mm	20 mm
Confezione	1440	1440	1440	720	360 pz.	288 pz.	288 pz.	144 pz.	72 pz.	72 pz.	48 pz.	24 pz.	12 pz.
Olivine (228)	X	X	X	X	X	X	X	X					
Olivine AB (228 AB)			X		X		X	X					
Pacific Opal (390)		X	X		X		X						
Palace Green Opal (393)		X	X		X		X						
Padparadscha (542)		X	X		X		X						
Padparadscha AB (542 AB)			X		X		X						
Peridot (214)	X	X	X	X	X	X	X	X	X	X			
Peridot AB (214 AB)			X		X		X	X					
Purple Velvet (277)		X	X		X		X						
Rosaline (508)			X		X		X	X					
Rose (209)	X	X	X	X	X	X	X	X					
Rose AB (209 AB)			X		X		X						
Rose Alabaster (293)		X	X		X		X						
Rose Water Opal (395)		X	X		X		X						
Ruby (501)									X	X			
Sand Opal (287)		X	X		X		X						
Sapphire (206)	X	X	X	X	X	X	X	X					
Sapphire AB (206 AB)			X		X		X	X					
Siam (208)	X	X	X	X	X	X	X	X					
Siam AB (208 AB)			X		X		X	X					
Silk (391)	X	X	X		X		X						
Smoked Topaz (220)	X	X	X	X	X	X	X	X					
Smoked Topaz AB (220 AB)			X		X		X						
Tanzanite (539)	X	X	X	X	X	X	X						
Tanzanite AB (539 AB)			X		X		X						
Topaz (203)	X	X	X	X	X	X	X	X					
Topaz AB (203 AB)			X		X		X						
Turquoise (267)			X		X		X						
Turquoise AB (267 AB)			X		X		X						
Vintage Rose (319)	X	X	X		X	X							
Violet (371)		X	X		X		X						
Violet AB (371 AB)			X		X		X						
Violet Opal (389)		X	X		X		X						
White Alabaster (281)	X	X	X		X		X						
White Opal (234)		X	X		X		X						
White Opal AB (234 AB)			X		X		X						



Articolo 5601

Misura:	4 mm	6 mm	8 mm	10 mm	12 mm
Confezione:	288	288 pz.	288 pz.	144 pz.	72 pz.
White Opal (234)	X	X	X	X	X
Crystal AB B (001 ABB)	X	X	X	X	X
Crystal Copper B (001 COPB)	X	X	X		
Crystal Golden Shadow B (001 GSHAB)	X	X	X		
Crystal Moonlight B (001 MOLB)	X	X	X		
Crystal Silver Shade B (001 SSHAB)	X	X	X		
Crystal Vitrail Medium B (001 VMB)	X	X	X		
Jet (280)	X	X	X		
Amethyst (204)	X	X	X		
Amethyst AB B (204 ABB)	X	X	X		
Aquamarine (202)	X	X	X		
Aquamarine AB B (202 ABB)	X	X	X		
Black Diamond (215)	X	X	X		
Caribbean Blue Opal (394)	X	X	X		
Chrysolite (238)	X	X	X		
Dark Red Coral (396)	X	X	X		
Emerald (205)	X	X	X		
Fuchsia (502)	X	X	X		
Fuchsia AB B (502 ABB)	X	X	X		
Khaki (550)	X	X	X		
Light Amethyst (212)	X	X	X		
Light Colorado Topaz (246)	X	X	X		
Light Grey Opal (383)	X	X	X		
Light Rose (223)	X	X	X		
Light Rose AB B (223 ABB)	X	X	X		
Light Sapphire (211)	X	X	X		



Articolo 5601

Misura:	4 mm	6 mm	8 mm	10 mm	12 mm
Confezione:	288	288 pz.	288 pz.	144 pz.	72 pz.
Light Sapphire AB B (211 ABB)	X	X	X		
Light Siam (227)	X	X	X		
Light Topaz (226)	X	X	X		
Mint Alabaster (397)	X	X	X		
Mocca (286)	X	X	X		
Pacific Opal (390)	X	X	X		
Padparadscha (542)	X	X	X		
Palace Green Opal (393)	X	X	X		
Peridot (214)	X	X	X		
Peridor AB B (214 ABB)	X	X	X		
Purple Velvet (277)	X	X	X		
Rose (209)	X	X	X		
Rose AB B (209 ABB)	X	X	X		
Rose Water Opal (395)	X	X	X		
Sand Opal (287)	X	X	X		
Sapphire (206)	X	X	X		
Siam (208)	X	X	X		
Siam AB B (208 ABB)	X	X	X		
Silk (391)	X	X	X		
Tanzanite (539)	X	X	X		
Tanzanite AB B (539 ABB)	X	X	X		
Topaz (203)	X	X	X		
Turquoise (267)	X	X	X		
Vintage Rose (319)	X	X	X		
Violet Opal (389)	X	X	X		
White Alabaster (281)	X	X	X		



Articolo 6000

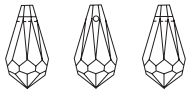

Misura:

Confezione:

11x5,5	13x6,5	15x7,5	22x11 mm	28x14 mm
288	288 pz.	144 pz.	48 pz.	24 pz.

	Crystal (001)	X	X	X	X	X
	Crystal AB (001 AB)	X	X	X	X	X
	Jet (280)	X	X	X	X	
	Amethyst (204)	X	X	X		
	Aquamarine (202)	X	X	X		
	Emerald (205)	X	X	X		
	Light Siam (227)	X	X	X		
	Rose (209)	X	X	X		
	Sapphire (206)	X	X	X		
	Siam (208)	X	X	X		
	Tanzanite (539)	X	X	X		
	Topaz (203)	X	X	X		



Articolo 6007

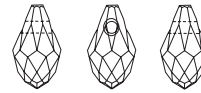

Misura:

Confezione:

7x4 mm	9x5 mm	
720 pz.	288 pz.	

	Crystal (001)	X	X
	Crystal AB (001 AB)	X	X
	Crystal Copper (001 COP)	X	X
	Crystal Golden Shadow (001 GSHA)	X	X
	Crystal Moonlight (001 MOL)	X	X
	Crystal Silver Shade (001 SSHA)	X	X
	Jet (280)	X	X
	Light Rose (223)	X	X
	Light Sapphire (211)	X	X
	Peridot (214)	X	X
	Siam (208)	X	X
	Tanzanite (539)	X	X
	Topaz (203)	X	X



Articolo 6002



Misura:

Confezione:

10x7 mm	15x11,5 mm	
288 pz.	72 pz.	

	Crystal (001)	X	X
	Crystal AB (001 AB)	X	X



Articolo 6090

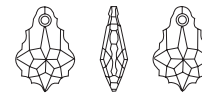

Misura:

Confezione:

16X11 mm	22X15 mm	
72 pz.	48 pz.	

	Crystal (001)	X	X
	Crystal AB (001 AB)	X	X
	Crystal Golden Shadow (001 GSHA)	X	X
	Jet (280)	X	X
	Amethyst (204)	X	X
	Aquamarine (202)	X	X
	Black Diamond (215)	X	X
	Light Amethyst (212)	X	X
	Light Colorado Topaz (246)	X	X
	Light Rose (223)	X	X
	Light Topaz (2269)	X	X
	Olivine (228)	X	X
	Ruby (501)	X	X
	Topaz (203)	X	X



Articolo 6100



Misura:

Confezione:



20 mm

72 pz.

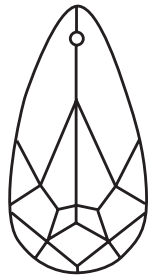

Crystal (001)	X	X
Crystal AB (001 AB)	X	X
Crystal Bermuda Blue (001 BBL)	X	
Crystal Vitrail Light (001 VL)	X	
Crystal Vitrail Medium (001 VM)	X	
Airopal (375)	X	
Fireopal (237)	X	
Oceanblue (376)	X	
Terrenum (377)	X	



Articolo 6200

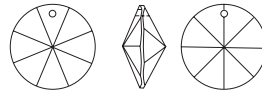

Misura:

Confezione:



6 mm

720 pz.



8 mm.

144 pz.

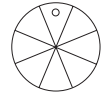

12 mm.

144 pz.

Crystal (001)	X	X	X
Crystal AB (001 AB)	X	X	X
Jet (280)	X	X	
Amethyst (204)	X	X	
Aquamarine (202)	X	X	
Chrysolite (238)	X	X	
Light Colorado Topaz (246)	X	X	
Light Siam (227)	X	X	
Rose (209)	X	X	
Siam (208)	X	X	
Violet (371)	X	X	



Articolo 6460

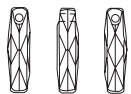

Misura:

Confezione:



20 mm

72 pz.

Crystal AB (001 AB)	X
Crystal AB (001 AB)	X
Crystal Copper (001 COP)	X
Crystal Golden Shadow (001 GSXA)	X
Crystal Satin (001 SAT)	X
Crystal Silver Shade (001 SSHA)	X



Articolo 6791

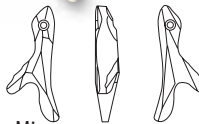

Misura:

Confezione:

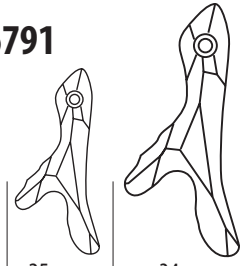

25 mm

48 pz.



34 mm

24 pz.

Crystal (001)	X	X
Crystal Copper (001 COP)	X	X
Crystal Golden Shadow (001 GSXA)	X	X
Crystal Moonlight (001 MOL)	X	X
Crystal Silver Shade (001 SSHA)	X	X
Jet (280)	X	X
Amethyst (204)	X	
Aquamarine (202)	X	
Black Diamond (215)	X	
Light Amethyst (212)	X	
Topaz (203)	X	



Articolo 6621

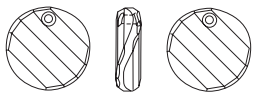

Misura:

Confezione:

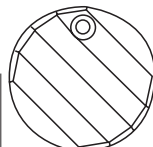

20 mm

24 pz.

Crystal (001)	X
Crystal Copper (001 COP)	X
Crystal Golden Shadow (001 GSXA)	X
Crystal Moonlight (001 MOL)	X
Crystal Silver Shade (001 SSHA)	X
Jet (280)	X

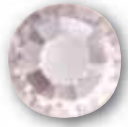

Articolo 2028

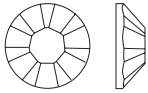

Misura:

Confezione

	 SS5	 SS6*	 SS8	 SS10*	 SS12	 SS16*	 SS20*	 SS30	 SS34*	 SS40
	1,80	2,00	2,40	2,80	3,20mm	4mm	4,80mm	6,50mm	7,27mm	8,67mm
	1440	1440	1440	1140	1440 pz.	1440 pz.	1440 pz.	360 pz.	144 pz.	144 pz.
 Crystal M HF (001)	X	X	X	X	X	X	X	X	X	X
 Crystal Hotfix Transparent (001 HFT)		X	X	X		X				
 Crystal AB M HF (001 AB)	X	X	X	X	X	X	X	X	X	X
 Crystal Copper M HF (001 COP)		X	X	X	X	X	X		X	
 Crystal Cosmojet M HF (001 COS)		X	X	X	X	X				
 Crystal Dorado M HF (001 DOR)		X	X	X	X	X	X		X	
 Crystal Golden Shadow M HF (001 GSHA)		X	X	X	X	X	X		X	
 Crystal Meridian Blue M HF (001 MBL)		X	X	X	X	X	X		X	
 Crystal Metallic Blue M HF (001 METBL)		X	X	X	X	X	X		X	
 Crystal Moonlight M HF (001 MOL)		X	X	X	X	X	X		X	
 Crystal Sage M HF (001 SAG)		X	X	X	X	X	X		X	
 Crystal Silver Shade M HF (001 SSHA)		X	X	X	X	X	X		X	
 Crystal Tabac M HF (001 TAB)		X	X	X	X	X	X		X	
 Crystal Transmission HFT (001 TRA HFT)		X	X	X	X	X	X		X	
 Crystal Volcano M HF (001 VOL)		X	X	X	X	X	X		X	
 Jet M HF (280)	X	X	X	X	X	X	X	X	X	
 Jet AB M HF (280 AB)	X	X	X	X	X	X	X	X	X	
 Jet Hematite M HF (280 HEM)	X	X	X	X	X	X	X	X	X	
 Jet Nut M HF (280 NUT)		X	X	X	X	X	X		X	
 Amethyst M HF (204)	X	X	X	X	X	X	X	X	X	
 Aquamarine M HF (202)	X	X	X	X	X	X	X	X	X	
 Black Diamond M HF (215)	X	X	X	X	X	X	X	X	X	
 Blue Zircon M HF (229)	X	X	X	X	X	X	X	X	X	
 Blue Zircon Satin M HF (229 SAT)		X	X	X	X	X	X		X	
 Burgundy M HF (515)		X	X	X	X	X	X		X	
 Capri Blue M HF (243)	X	X	X	X	X	X	X	X	X	
 Caribbean Blue Opal M HF (394)		X	X	X	X	X	X		X	
 Chalkwhite M HF (279)		X	X	X	X	X	X		X	
 Chrysolite M HF (238)		X	X	X	X	X	X		X	
 Citrine M HF (249)		X	X	X	X	X	X		X	
 Cobalt M HF (369)		X	X	X	X	X	X		X	
 Emerald M HF (205)	X	X	X	X	X	X	X	X	X	
 Erinite M HF (360)		X	X	X	X	X	X		X	
 Fireopal M HF (237)				X	X	X	X		X	
 Fuchsia M HF (502)	X	X	X	X	X	X	X	X	X	
 Hyacint M HF (236)	X	X	X	X	X	X	X	X	X	
 Jonquil M HF (213)	X	X	X	X	X	X	X	X	X	

* misure applicabili con penna attacca strass

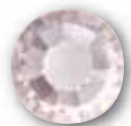

Articolo 2028

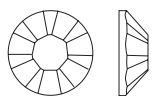

Misura:

Confezione

	 SS5	 SS6*	 SS8	 SS10*	 SS12	 SS16*	 SS20*	 SS30	 SS34*	 SS40
	1,80	2,00	2,40	2,80	3,20mm	4mm	4,80mm	6,50mm	7,27mm	8,67mm
	1440	1440	1440	1140	1440 pz.	1440 pz.	1440 pz.	360 pz.	144 pz.	144 pz.
 Jonquil AB M HF (213 AB)	X	X	X	X	X	X	X	X	X	
 Jonquil Satin M HF (213 SAT)		X	X	X	X	X	X		X	
 Khaki M HF (550)		X	X	X	X	X	X		X	
 Light Amethyst M HF (212)	X	X	X	X	X	X	X	X	X	
 Light Colorado Topz M HF (246)	X	X	X	X	X	X	X	X	X	
 Light Grey Opal M HF (383)		X	X	X	X	X	X		X	
 Light Peach M HF (362)		X	X	X	X	X	X		X	
 Light Rose M HF (223)	X	X	X	X	X	X	X	X	X	
 Light Rose AB M HF (223 AB)		X	X	X	X	X	X		X	
 Light Sapphire M HF (211)	X	X	X	X	X	X	X	X	X	
 Light Siam M HF (227)	X	X	X	X	X	X	X	X	X	
 Light Siam AB M HF (227 AB)	X	X	X	X	X	X	X	X	X	
 Light Siam Satin M HF (227 SAT)		X	X	X	X	X	X		X	
 Light Topaz M HF (226)		X	X	X	X	X	X		X	
 Mint Alabaster Hotfix Transparent (397 HFT)		X	X	X	X	X	X		X	
 Mocca M HF (286)		X	X	X	X	X	X		X	
 Montana M HF (207)	X	X	X	X	X	X	X	X	X	
 Olivine M HF (228)	X	X	X	X	X	X	X	X	X	
 Pacific Opal M HF (390)		X	X	X	X	X	X		X	
 Padparadscha M HF (542)		X	X	X	X	X	X		X	
 Palace Green Opal M HF (393)		X	X	X	X	X	X		X	
 Peridot M HF (214)	X	X	X	X	X	X	X	X	X	
 Purple Velvet M HF (277)		X	X	X	X	X	X		X	
 Rose M HF (209)	X	X	X	X	X	X	X	X	X	
 Ruby M HF (501)	X	X	X	X	X	X	X	X	X	
 Sand Opal M HF (287)		X	X	X	X	X	X		X	
 Sapphire M HF (206)	X	X	X	X	X	X	X	X	X	
 Sapphire Satin M HF (206 SAT)		X	X	X	X	X	X		X	
 Siam M HF (208)	X	X	X	X	X	X	X	X	X	
 Silk M HF (391)		X	X	X	X	X	X		X	
 Smoked Topaz M HF (220)	X	X	X	X	X	X	X	X	X	
 Smoked Topaz Satin M HF (220 SAT)		X	X	X	X	X	X		X	
 Sun M HF (248)		X	X	X	X	X	X		X	
 Tanzanite M HF (539)		X	X	X	X	X	X		X	
 Topaz M HF (203)	X	X	X	X	X	X	X	X	X	
 Topaz AB M HF (203 AB)	X	X	X	X	X	X	X	X	X	
 Vintage Rose M HF (319)		X	X	X	X	X	X		X	
 White Opal M HF (234)		X	X	X	X	X	X		X	

*misure applicabili con penna attaccastress



Articolo 2711

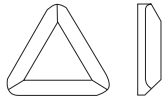

Misura: 6 mm
Confezione: 360 pz.

Crystal M HF (001)	X
Crystal AB M HF (001 AB)	X
Jet M HF (280)	X
Jet Hematite M HF (280 HEM)	X



Articolo 2400

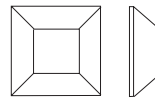

Misura: 3 4 mm
Confezione: 1440 720 pz.

Crystal M HF (001)	X	X
Crystal AB M HF (001 AB)	X	X
Crystal Copper M HF (001 COP)	X	X
Crystal Golden Shadow M HF (001 GSHA)	X	X
Crystal Silver Shade M HF (001 SSHA)	X	X
Jet M HF (280)	X	X
Jet Hematite M HF (280 HEM)	X	X
Aquamarine M HF (202)	X	X
Light Rose M HF (223)	X	X
Light Siam M HF (227)	X	X



Articolo 2728

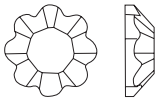

Misura: SS10 2,80 4 mm SS16 4 mm SS20 4,80 mm SS34 7,27 mm
Confezione: 1440 1440 1440 pz. 144 pz.

Crystal M HF (001)	X	X	X	X
Crystal AB M HF (001 AB)	X	X	X	X



Articolo 2300

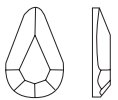

Misura: 8x4,8 mm
Confezione: 720 pz.

Crystal M HF (001)	X
Crystal AB M HF (001 AB)	X
Jet M HF (280)	X
Jet Hematite M HF (280 HEM)	X



Articolo 2510

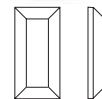

Misura: 5x2,5 mm
Confezione: 1440pz.

Crystal M HF (001)	X
Crystal AB M HF (001 AB)	X
Jet M HF (280)	X
Jet Hematite M HF (280 HEM)	X



Articolo 2610

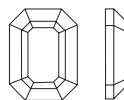

Misura: 6x4 mm
Confezione: 1440pz.

Crystal M HF (001)	X
Crystal AB M HF (001 AB)	X
Jet M HF (280)	X
Jet Hematite M HF (280 HEM)	X



Articolo 2200

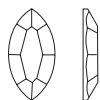

Misura:	8x4 mm
Confezione:	720 pz.
Crystal M HF (001)	X
Crystal AB M HF (001 AB)	X
Jet M HF (280)	X
Jet Hematite M HF (280 HEM)	X

Penna per applicare strass termoadesivi



ISTRUZIONI:

- 1 Prendere l'applicatore, inserire la punta corrispondente alla misura dello strass da applicare
- 2 Dopo qualche secondo posare la punta della penna sulla parte brillante dello strass che rimarrà incastrato nella punta
- 3 Appoggiare lo strass sulla superficie che volete decorare per qualche secondo.
La colla che c'è dietro allo strass si scioglierà e rimarrà attaccata alla Vs. superficie (tessuto, pelle, ecc...)

- penna articolo 6000
- punta per strass misura SS06 ART. 6050
- punta per strass misura SS10 ART. 6051
- punta per strass misura SS16 ART. 6052
- punta per strass misura SS20 ART. 6053
- punta per strass misura SS34 ART. 6054



Articolo 2080/4



Misura:	SS10 2,80	SS16 4 mm	SS34 7,27 mm
Confezione:	1440	1440	144 pz.
Crystal Frosted M HF (001 FRO)	X	X	X
Crystal Frosted AB M HF (001 FRO AB)	X	X	X
Jet M HF (280)	X	X	X
Jet Hematite M HF (280 HEM)	X	X	X
Chalkwhite Creampearl M HF (279 CPL)	X	X	X
Chalkwhite Nacre M HF (279 NAC)	X	X	X



Articolo 2180/4



Misura:	8x4 mm
Confezione:	720 pz.
Crystal M HF (001)	X
Crystal AB M HF (001 AB)	X
Jet M HF (280)	X
Jet Hematite M HF (280 HEM)	X



Articolo 3016

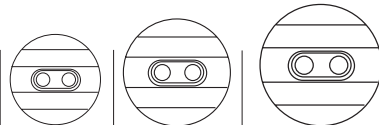
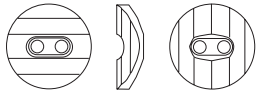

Misura:	12 mm	14 mm	16 mm
Confezione:	48 pz.	36 pz.	24 pz.
Crystal M (001)	X	X	X
Crystal AB M (001 AB)	X	X	X
Crystal Golden Shadow M (001 GSHA)	X	X	X
Crystal Satin M (001 SAT)	X	X	X
Crystal Tabac M (001 TAB)	X	X	X
Crystal Volcano M (001 VOL)	X	X	X
Jet (280)	X	X	X
Jet Hematite (280 HEM)	X	X	X
Jet Nut (280 NUT)	X	X	X
Aquamarine M (202)	X	X	X
Burgundy M (515)	X	X	X
Chrysolite M (238)	X	X	X
Light Amethyst M (212)	X	X	X
Light Colorato Topaz M (246)	X	X	X
Montana M (207)	X	X	X



Articolo 3035

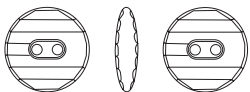

Misura:	10 mm	12 mm	14 mm
Confezione:	72 pz.	48 pz.	36 pz.
Crystal M (001)	X	X	X
Crystal AB M (001 AB)	X	X	X
Crystal Satin M (001 SAT)	X	X	X
Jet (280)	X	X	X
Jet Hematite (280 HEM)	X	X	X



Articolo 3017

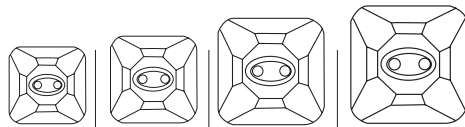
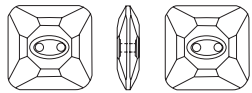

Misura:	10 mm	12 mm	14 mm	16 mm
Confezione:	72 pz.	48 pz.	36 pz.	24 pz.
Crystal M (001)	X	X	X	X
Crystal AB M (001 AB)	X	X	X	X
Crystal Golden Shadow M (001 GSHA)	X	X	X	X
Crystal Meridian Blue M (001 MBL)	X	X	X	X
Crystal Satin M (001 SAT)	X	X	X	X
Crystal Tabac M (001 TAB)	X	X	X	X
Crystal Volcano M (001 VOL)	X	X	X	X
Jet (280)	X	X	X	X
Jet Hematite (280 HEM)	X	X	X	X
Jet Nut (280 NUT)				
	X	X	X	X
Aquamarine M (202)	X	X	X	X
Burgundy M (515)	X	X	X	X
Chrysolite M (238)	X	X	X	X
Light Amethyst M (212)	X	X	X	X
Light Colorato Topaz M (246)	X	X	X	X
Montana M (207)	X	X	X	X
Padparadscha M (542)	X	X	X	X



Articolo 3036

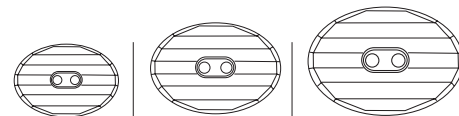
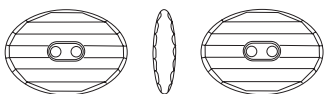

Misura:	14x10 mm	17x12 mm	20x14 mm
Confezione:	48 pz.	36 pz.	24 pz.
Crystal M (001)	X	X	X
Crystal AB M (001 AB)	X	X	X
Crystal Satin M (001 SAT)	X	X	X
Jet (280)	X	X	X
Jet Hematite (280 HEM)	X	X	X



Articolo 3037

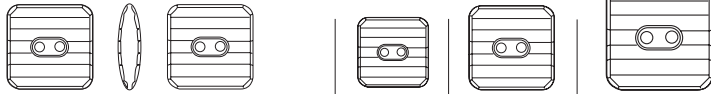

Misura:	10 mm	12 mm	14 mm
Confezione:	72 pz.	48 pz.	36 pz.
Crystal M (001)	X	X	X
Crystal AB M (001 AB)	X	X	X
Crystal Satin M (001 SAT)	X	X	X
Jet (280)	X	X	X
Jet Hematite (280 HEM)	X	X	X



Articolo 3122



Misura:	10 mm
Confezione:	72 pz.
Crystal M (001)	X
Crystal AB (001 AB)	X
Crystal AB M (001 AB)	X
Crystal Satin M (001 SAT)	X
Crystal Tabac M (001 TAB)	X
Jet (280)	X



Articolo 3093



Misura:	21x11 mm	30x16 mm
Confezione:	36 pz.	30 pz.
Crystal M (001)	X	X
Crystal AB M (001 AB)	X	X
Crystal Copper M (001 COP)	X	X
Crystal Tabac M (001 TAB)	X	X
Crystal Volcano M (001 VOL)	X	X
Jet (280)	X	X
Jet Hematite (280 HEM)	X	X
Jet Nut (280 NUT)	X	X
Black Diamond M (215)	X	X
Light Colorado Topaz M (246)	X	X



Articolo 3014

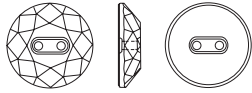

Misura:	12 mm	14 mm	16 mm
Confezione:	48 pz.	36 pz.	24 pz.
Crystal M (001)	X	X	X
Crystal AB M (001 AB)	X	X	X
Crystal Satin M (001 SAT)	X	X	X
Crystal Volcano M (001 VOL)	X	X	X
Jet (280)	X	X	X
Jet Hematite (280 HEM)	X	X	X
Jet Nut (280 NUT)	X	X	X



Articolo 3015

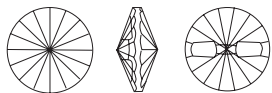

Misura:	10 mm	12 mm	14 mm	16 mm	18 mm	23 mm	27 mm
Confezione:	72 pz.	48 pz.	36 pz.	24 pz.	24 pz.	8 pz.	8 pz.
Crystal M (001)	X	X	X	X	X	X	X
Crystal AB M (001 AB)	X	X	X	X	X	X	X
Crystal Golden Shadow M (001 GSHA)	X	X	X	X			
Crystal Meridian Blue M (001 MBL)	X	X	X	X			
Crystal Sage M (001 SAG)	X	X	X	X			
Crystal Satin M (001 SAT)	X	X	X	X			
Crystal Tabac M (001 TAB)	X	X	X	X			
Crystal Transmission V (001 TRAV)	X	X	X	X			
Crystal Volcano M (001 VOL)	X	X	X	X			
Jet (280)	X	X	X	X	X	X	X
Jet Hematite (280 HEM)	X	X	X	X			
Jet Nut (280 NUT)	X	X	X	X			
Aquamarine M (202)	X	X	X	X			
Black Diamond M (215)	X	X	X	X			
Burgundy M (515)	X	X	X	X			
Chrysolite M (238)	X	X	X	X			
Erinite M (360)	X	X	X	X			
Light Amethyst M (212)	X	X	X	X			
Light Colorado Topaz M (246)	X	X	X	X			
Montana F (207)	X	X	X	X			



Goccia Conica incastonata



Misura:	8x4.8 mm	10x6 mm	13x7,8 mm
Confezione:	144 pz.	144 pz.	144 pz.
Articolo con castone argento:	3/3G0848	7192-9055	7192-9049
Articolo con castone oro:	3/3G0848.oro	7192-9055.oro	7192-9049.oro



Navetta Conica incastonata



Misura:	6x3 mm	8x4 mm	10x5 mm	15x7 mm
Confezione:	144pz.	144 pz.	144 pz.	144 pz.
Articolo con castone argento:	3/3NA63	3/3NA84	7192-9056	7192-9048
Articolo con castone oro:	3/3NA63.oro	3/3NA84.oro	7192-9056.oro	7172-9048.o



Quadrato Conico incastonato



Misura:	4 mm	6 mm
Confezione:	288pz.	288 pz.
Articolo con castone argento:	7192-0005	7192-9040
Articolo con castone oro:	7192-0005.oro	7192-9040.oro



Ovale Conico incastonato



Misura:	8x6 mm	10x8 mm
Confezione:	144pz.	144 pz.
Articolo con castone argento:	3/30V86	7192-9047
Articolo con castone oro:	3/30V86.oro	7192-9047.oro

Strass Conico incastonato



Misura:	SS/16	SS/20	SS/30
	4 mm.	4.80 mm.	6.50 mm.
Confezione:	1440pz.	720 pz.	288 pz.
Articolo con castone argento:	7192-5021	7192-5022	7192-7085
Articolo con castone oro:	7192-5021.oro	7192-5022.oro	7192-7085.oro

Strass Piatti incastonati



Misura:	SS/10	SS/12	SS/16	SS/20	SS/30
	2.80 mm.	3,20 mm.	4 mm.	4,80 mm.	6,50 mm.
Confezione:	1440pz.	1440 pz.	1440 pz.	1440 pz.	1440 pz.
Articolo con castone argento:	7192-9010	7192-9011	7192-9013	7192-9015	7192-9074
Articolo con castone oro:	7192-9010.oro	7192-9011.oro	7192-9013.oro	7192-9015.oro	7192-9074.oro

Ponte strass conf. 144 pz.



Misura:	13x6 mm	19x7 mm
Articolo con castone argento:	7112-9504	7112-9505
Articolo con castone oro:	7112-9504.oro	7112-9505.oro

Rondella strass conf. 144 pz.



Misura:	5 mm	6 mm	7 mm	8 mm	9 mm	10 mm
Articolo con castone argento:	7112-9105	7112-9155	7112-9106	7112-9107	7112-9109	7112-9110
Articolo con castone oro:	7112-9105.oro	7112-9155.oro	7112-9106.oro	7112-9107.oro	7112-9109.oro	7112-9110.oro

Pallina strass conf. 144 pz.



Misura:	8 mm	10 mm
Articolo con castone argento:	7192-6001	7192-6002
Articolo con castone oro:	7192.6001.oro	7192-6002.oro

Articolo 137102



Misura: 15 mm
 Confezione: 144 pz.
 Articolo con castone oro: 137102.oro
 Articolo con castone argento: 137102.arg

Articolo 147603



Misura: 20 mm
 Confezione: 144 pz.
 Articolo con castone oro: 147603.oro
 Articolo con castone argento: 147603.arg

Articolo 137310

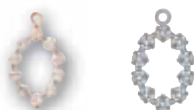

Misura: 13x9,7 mm
 Confezione: 144 pz.
 Articolo con castone oro: 137310.oro
 Articolo con castone argento: 137310.arg

Articolo 117009

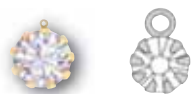

Misura: 5 mm
 Confezione: 144 pz.
 Articolo con castone oro: 117009.oro
 Articolo con castone argento: 117009.arg

Paillettes confezione 10 mazze



MISURA:	mm. 3	mm. 4	mm. 5	mm. 6	mm. 8	mm. 10	mm. 12	mm. 18
CONFEZIONE MINIMA 10 MAZZE								
=	170 gr.	300 gr.	500 gr.	750 gr.	1350 gr.	2100 gr.	3100 gr.	6500 gr.

Couvettes confezione 10 mazze



MISURA:	mm. 3	mm. 4	mm. 5	mm. 6	mm. 8	mm. 10
CONFEZIONE MINIMA 10 MAZZE						
=	170 gr.	300 gr.	500 gr.	750 gr.	1350 gr.	2100 gr.

Irisé trasparenti

101		125		124		106		7400	
110		109		5080		122		111	
128		116		120		107		113	
139		133		121		108		126	
114		138		119		140		137	
134		132		118		123		136	

Orientali

572		159		4163		164		7353	
102		562		707		6233		5020	
150		154		560		576		161	

Irisé metallizzati

1115		2215		3075		7025		9275	
2015		2345		6015		8175			

Colori speciali

1121		3160		1112		255		2	
2021		3140				1		3	

C o u v e t t e s e p a i l l e t t e s



C/06.510



C/06.512



C/06.516



C/06.504



C/06.532



C/06.531



C/06.533

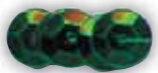

C/06.534



C/06.537



C/06.524



C/06.530



C/06.529



C/06.505



C/06.522



C/06.522



C/06.523



C/06.519



C/06.526



C/06.518



C/06.536



C/06.513



C/06.517



C/06.520



C/06.503



C/06.515



C/06.521



C/06.509



C/06.507



C/06.506



C/06.527



C/06.508

* cartella colori valida solo per couvettes mm. 6 - Confezione da 1 Kg

Perle barocche conf. 50 pz.



Pasqua mm. 6. 1



Pasqua mm. 6. 12

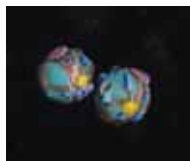

Pasqua mm. 6. 31



Pasqua mm. 6. tras. 12



Rosetta mm. 6. 3



Rosetta mm. 6. 1



Rosetta mm. 6. 16



Rosetta mm. 06. 12

Perle conf. 12 fili da mt. 1,50 l'uno. Disponibili in colore bianco e avorio



Pietre dure conf. 10 fili da 40 cm. l'uno



Acquamarina



Citrino



Corallo Rosa



Corallo Rosso



Cristallo



Luna



Madreperla



Madreperla 4x8



Rametti



Turchese

CONFEZIONE da 1 KG.



1/2. TRASP.
mm. 2



1/2. IRISE'
mm. 2



1/2.000
mm. 2



1/2.0099
mm. 2



1/2.10/0.01
mm. 2



1/2.12/0.01
mm. 1,5



1/2.SATIN
mm. 2



12.12/0.SATIN
mm. 1,5



1/2.INT
mm. 2



1/2.2
mm. 2



1/2.BCO.IRISE
mm. 2



1/2.SETA
mm. 2



1/2.12
mm. 1,5



1/2.6
mm. 2



1/2.7
mm. 2



1/2.16
mm. 2



1/2.19
mm. 2



1/2.11
mm. 2



N.1/2.BCO.IR
mm. 2



N.1/2.TRASP
mm. 1,5



12/0.11.
mm. 0,5



12/0.19
mm. 0,5



12/0.IRISE'
mm. 0,5



N.12/0.TRASP.
mm. 0,5



N.12/0SETA
mm. 0,5



N.12/0.ARG
mm. 0,5



12/0.000
mm. 0,5



12/0.0099
mm. 0,5



12/0.INT
mm. 0,5



12/0.2
mm. 0,5



09/0.01
mm. 1,5



08/0.SETA
mm. 1,5



12/0.600
mm. 1



2.IRISE'
mm. 4



2.SATIN
mm. 4



2.MIELE
mm. 4



11/0.IRISE'
mm. 1



11/0.SETA
mm. 1



12/0.602
mm. 1



12/0.601
mm. 1



12/0.621
mm. 1



12/0.612
mm. 1



12/0.613
mm. 1



12/0.614
mm. 1



12/0.633
mm. 1



12/0.635
mm. 1



12/0.637
mm. 1



12/0.639
mm. 1



12/0.644
mm. 1



12/0.643
mm. 1



12/0.645
mm. 1



12/0.664
mm. 1



12/0.661
mm. 1

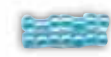

12/0.657
mm. 1



12/0.658
mm. 1



12/0.659
mm. 1



12/0.632
mm. 1



12/0.616
mm. 1



12/0.668
mm. 1



12/0.670
mm. 1



12/0.673
mm. 1

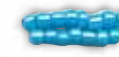

12/0.656
mm. 1



12/0.628
mm. 1



12/0.629
mm. 1



12/0.649
mm. 1



12/0.640
mm. 1



12/0.642
mm. 1



12/0.627
mm. 1



12/0.681
mm. 1



12/0.618
mm. 1



12/0.653
mm. 1



12/0.655
mm. 1



12/0.611
mm. 1



12/0.663
mm. 1



12/0.605
mm. 1



12/0.610
mm. 1



12/0.609
mm. 1

CONFEZIONE da 1 KG.



12/0.608
mm. 1



12/0.607
mm. 1



12/0.606
mm. 1



1/2.601
mm. 2



1/2.600
mm. 2



1/2.660
mm. 2



1/2.659
mm. 2



1/2.662
mm. 2



1/2.664
mm. 2

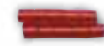

1/2.649
mm. 2



1/2.648
mm. 2



1/2.639
mm. 2



1/2.672
mm. 2



1/2.668
mm. 2



1/2.626
mm. 2



1/2.631
mm. 2



1/2.614
mm. 2



1/2.617
mm. 2



1/2.606
mm. 2



1/2.605
mm. 1,5



1/2.611
mm. 2



1/2.600
mm. 2

CONFEZIONE da 1200 pz.



MM.4.B01
mm. 4



MM.4.B43
mm. 4



MM.4.B02
mm. 4



MM.4.B29
mm. 4



MM.4.B22
mm. 4



MM.4.B15
mm. 4



MM.4.B12
mm. 4



MM.4.B23
mm. 4



MM.4.B40
mm. 4



MM.4.B27
mm. 4



MM.4.B13
mm. 4



MM.4.B14
mm. 4



MM.4.B15
mm. 4



MM.4.B16
mm. 4



MM.4.B06
mm. 4



MM.4.B07
mm. 4



MM.4.B05
mm. 4



MM.4.B09
mm. 4



MM.4.B37
mm. 4



MM.4.B28
mm. 4



MM.4.B11
mm. 4



MM.4.B34
mm. 4



MM.4.B18
mm. 4



MM.4.B19
mm. 4



MM.4.B21
mm. 4



MM.4.B31
mm. 4



MM.4.B39
mm. 4



MM.4.B38
mm. 4



MM.4.B41
mm. 4



MM.4.B36
mm. 4



MM.4.B35
mm. 4



MM.4.B47
mm. 4



MM.4.B48
mm. 4



MM.4.B42
mm. 4



via Lugani, 11
28010 Nebbiuno (NO) - Italy

Tel. +39 0322 58693
Fax +39 0322 589641
info@montorfano.com

www.montorfano.com
www.montorfano.shop.com